

# BRICON

## SPEEDY



## User Guide

United Kingdom

Version UK-14 or higher

**BRICON nv**

Europark Oost 15c, 9100 Sint-Niklaas, Belgium.

Tel: +32 3 777 39 74 email: [bricon@bricon.be](mailto:bricon@bricon.be)

International website: [www.bricon.be](http://www.bricon.be) UK website: [www.briconuk.com](http://www.briconuk.com)

## SPEEDY SECURITY

- *Security is paramount to Bricon and the Speedy employs a safe housing system sealed at production.*
- *A system can only be compromised if its electronic driving system is accessed, but the Speedy will not allow this without damage to the housing.*
- *TNO reports prove the efficiency of this technique.*
- *The Speedy also has a visible security stud found on the front top right corner of the clock. This security stud should remain intact at all times.*
- *Furthermore the Speedy has a holographic security sticker attached to the side of its housing which should remain in place at all times.*
- *The Speedy therefore does not require any accessible screws which can be open to abuse or argument.*
- *View of the housing should not be hindered by labels.*

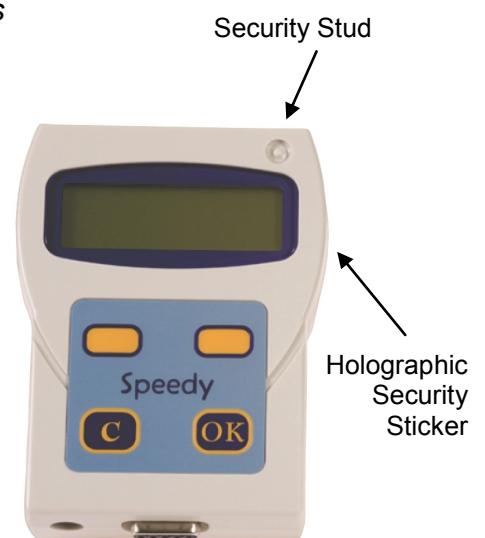

# Index:

	Page
1. The Bricon electronic timing system	4
1.1. Foreword	4
1.2. The Speedy system	4
1.3. Assembly schematic of the Bricon timing system	4
1.4. The Power Supply - Mains Electricity	5
1.5. Power from a Battery	5
2. Speedy Functionality	5
2.1. Get started by powering the system	5
2.2. The Keypad Buttons	5
2.3. The Menu	6
3. The Antenna Pad.	6
3.1. Pads available in different sizes - your choice	6
3.2. Connecting additional Antenna Pads	6
3.3. Programming an identity into additional Antenna Pads	7
3.4. Antenna Testing	7
3.5. Antenna Pad placement	8
4. Get up and running with the system	11
4.1. Input Fancier	11
4.2. Linking Birds	12
4.3. Browse Pigeons	12
4.4. Clocking Birds from Training	13
5. Racing with the Speedy	14
5.1. Competing in a club that uses a Bricon Club-Master	14
5.2. Competing in a club that uses an alternative brand of master	14
5.3. Basketing on an alternative brand of club master	14
5.4. Read out on an alternative brand of club master	16
5.5. To Delete a race from the Speedy	16
6. Additional Functions and Features	17
6.1. Setting the Date and Time	17
6.2. Basketed Races	17
6.3. Racepoints	17
6.4. Printing Lists	18
6.5. Antenna Alarm	18
6.6. Software updates	18
7. Optional System Enhancements.	
7.1. Continuous Clocking with the Bricon Plus	18
7.2. Bricon Print Manager	18
7.3. Clocking with two Speedy clocks.	18
8. Unives 1.7 Compatibility	18
9. Maintenance and Service	18
10. Frequently Asked Questions	19
11. Declaration of Conformity	20
12. Technical Specifications	20

# 1. The Bricon electronic timing system.

## 1.1. Foreword.

Thank you for your trust and confidence in BRICON.  
This user guide will give an explanation of the functions of your Speedy clock.

## 1.2. The Bricon Speedy system.

A complete Speedy system pack contains:

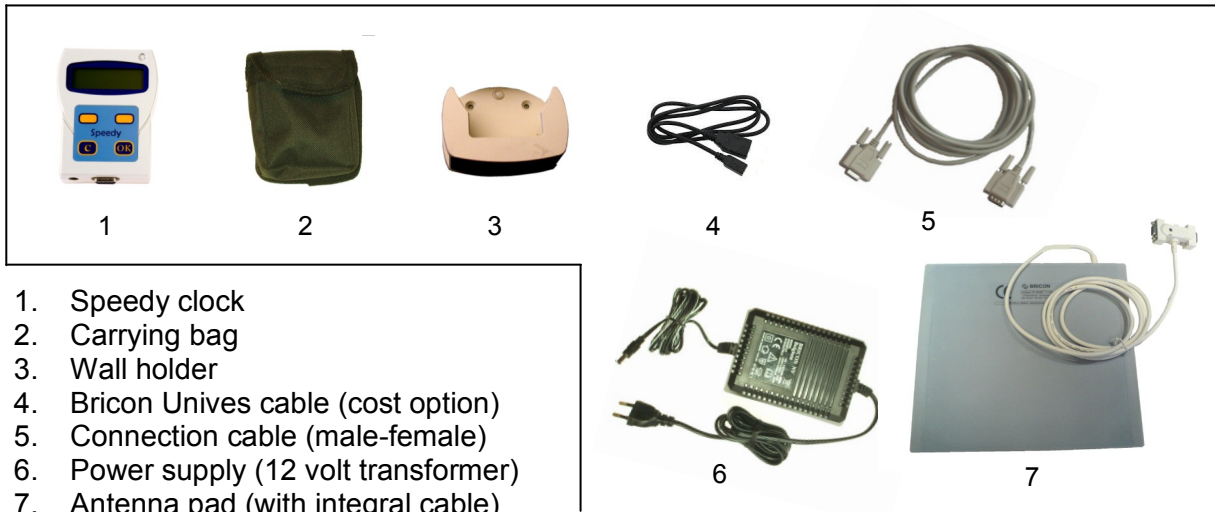

## 1.3. Assembly schematic of the Bricon timing system.

*- The assembly shown here is of a two antenna pad system.*

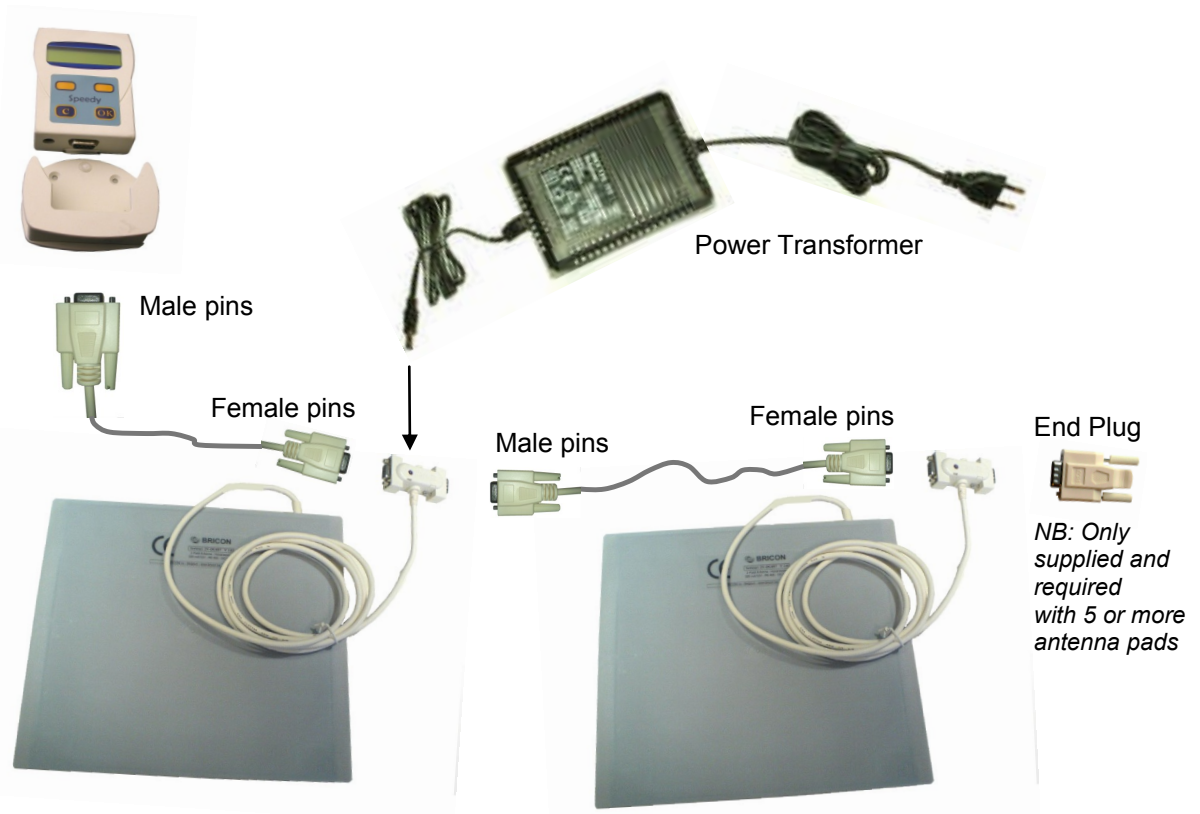

## 1.4. The Power Supply - Mains Electricity.

- The Bricon power supply is a 12 volt Transformer with a max rating of 1500mA (milliamps).
- This powerful and sturdy transformer is ample for any Bricon single antenna pad system.
- An additional power supply may be required when multiple antenna pads are connected.
- You can calculate your own system power requirements as each antenna pad is labelled with its power needs (from 290mA to 700mA) depending on size of the pad. The Speedy clock uses a further 70mA, so a calculation can be made to see if more than 1500mA is required.
- The power jack should be plugged into the jack socket on the Antenna T-connector.
- In a multiple antenna pad system, the power should be connected into the antennas so as to distribute the power around the system as evenly as possible.

## 1.5. Power from a Battery.

Lofts that are without mains electricity have the option to receive power for the Bricon system from a 12 volt battery using a Battery Connection cable. The crocodile clips on the cable will connect to any standard 12 volt battery, such as a car battery or a leisure battery.

## 2. Speedy Functionality.

### 2.1. Get started by powering the system.

Connect the Speedy clock within the system as illustrated in the plan in section 1.3. Turn on the power supply and the Speedy clock will power up and proceed through its initialisation process.

Press the <C> button and the menu of the Speedy will show on the display.



### 2.2. The Keypad Buttons.

The Speedy clock is very easy to use having only four buttons on the keypad which fully control the functionality of the clock. The four keys are as follows -

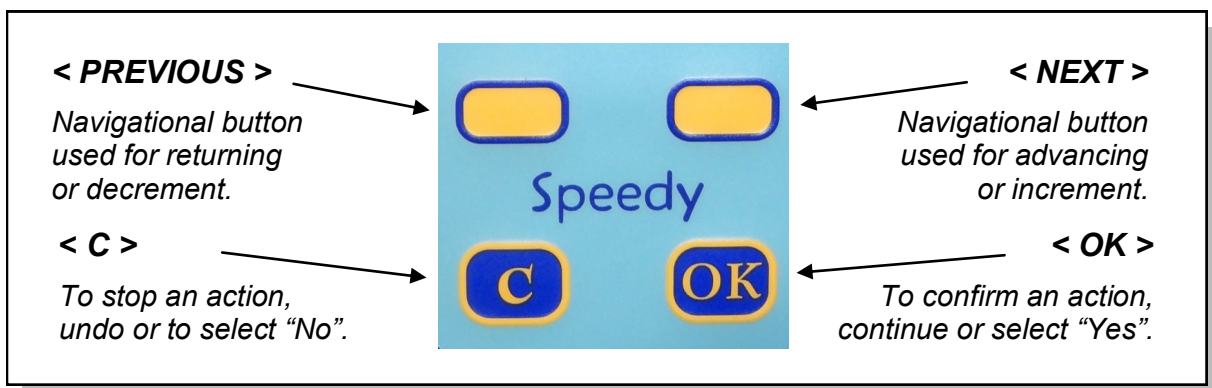









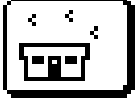

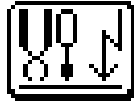

## 2.3. The Menu.

The complete functionality of Speedy clock is accessed through a menu using 15 main functions each graphically presented by a picture icon.

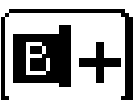
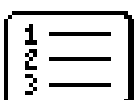
The icon that is required should be positioned in the centre of the Speedy display using the orange navigational buttons <PREVIOUS> and <NEXT> and then accessed by pressing the <OK>.

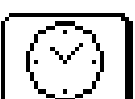
Listed below is each icon and its function.

 <i>Clocking</i>	 <i>Races</i>	 <i>Basketing</i>
 <i>Read out</i>	 <i>Delete</i>	 <i>Antenna test</i>
 <i>Antenna prog.</i>	 <i>Print clocking</i>	 <i>Print overview</i>
 <i>Linking birds</i>	 <i>Browse pigeons</i>	 <i>Input/Edit Fancier</i>
 <i>Set date - time</i>	 <i>Betting</i>	 <i>Racepoints</i>

*Please note: By holding down the <C> button you can see the text name of the icon.*

## 3. The Antenna Pad.

### 3.1. Pads available in different sizes - your choice

Bricon produces four sizes of antenna pads, with special technology that has electro-magnetic fields that uniquely overlap, and thus are the only pads designed to be used without tunnels.

- One Field = 163 mm wide.
  - Two Field = 282 mm wide
  - Four Field = 482 mm wide.
  - Six Field = 683 mm wide.
- All antenna pads are 253 mm deep and 22 mm thick.

The new G-series pads have a 2 metre integral cable to its T-connector (NB: early pads 1.8m).

### 3.2. Connecting additional Antenna Pads.

Additional antenna pads can be connected within the system with a Bricon connection cable which has a 9-pin male connector on one end and a 9-pin female connector on the other end. An end plug should only be fitted to the system when five or more antenna pads are connected. The Speedy will operate with up to 4 antenna pads of any size, and where 5 or more antennas are required then a Bricon Antenna Buffer must be connected within the system.



### 3.3. Programming an identity number into additional antenna pads.



When two or more antenna pads are connected in the same system, it is very important that each antenna is given its own internal identity (numbered between one and four). If two pads have the same identity number then at some stage there will be a data collision when the clocking information is forwarded to the clock and the system may cease to function.

Each antenna pad retains its own identity number within its own memory, and when purchased each antenna is pre-set as a number 1. When two or more antenna pads are connected then each pad in the system must be programmed to have its own identity number between 1 and 4.

The programming of each antenna pad should be carried out using the following procedure.

- (i) Ensure that the Speedy and each antenna are disconnected from one another.
- (ii) Connect the power supply directly into the base of the Speedy clock.
- (iii) After starting up the display will show the icon menu.
- (iv) Press <NEXT> to navigate through the menu to the 'Antenna Prog' icon and press <OK>.
- (v) Press the <NEXT> until the required identity number appears (between 1 and 4 only).
- (vi) Connect one antenna pad to the base of the Speedy clock and press <OK>.
- (vii) Programming is successful if the Speedy shows 'Antenna Progr : nr OK'
- (viii) If 'No Antenna available' appears, repeat the process ensuring that OK is pressed promptly.
- (ix) Disconnect the pad from the Speedy and repeat the process for additional pads.

### 3.4. Antenna Testing.



This function can be used to test the detection quality of the antennas electro-magnetic fields and to confirm that the antenna pads have been numbered correctly.

- (a) Connect the antenna pads together in the full system.
- (b) Connect the Speedy and using <NEXT> go to the 'Antenna Testing' icon and press <OK>.
- (c) A search will then be carried out by the Speedy for connected antenna pads.
- (d) If for example, three pads are connected the Speedy display should indicate ...

First Line  
The number of different antenna pad identities found in the search.

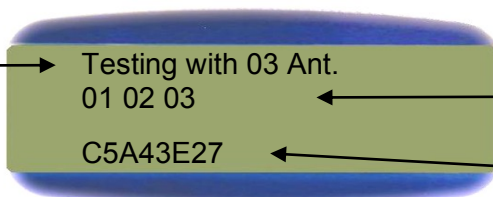

Second Line  
The antenna pad identity numbers found in the search  
The electronic chip number.

Antenna Testing allows you to confirm that the antenna installation has been carried out correctly and by placing an electronic chip over the pad that the registration quality is good.

The Speedy clock should beep repeatedly if the electronic chip is held above the antenna at a height of 5 to 7 cm (2 to 3 inches).

**VERY IMPORTANT:** *If the numbers of antennas shown does not match the actual number of antenna pads connected, then two antenna pads may have been given the same internal identity number indicating that the antenna programming has not been carried out correctly. Carry out testing on each antenna pad and check that the identity number for each pad is as intended.*

### 3.5. Antenna Pad placement.

**Very Important : Metal should not be situated near the antenna pad**  
(either underneath or above the pad).

**Metallic items, such as metal hinges, bars or wire mesh can cause undue interference to the timing system, causing the system to malfunction or cease operating.**

**Interference can also be caused by electrical devices and other electro-magnetic fields.**

As the signal will pass through most non-metallic materials, it is recommended to install the pad either above or beneath the loft entrance board (eg: plywood of no more than 15mm thickness). It is important that air-flow is allowed to the pads to enable the cooling process to take place.

The entrance hole to the loft must be at least 2 cm narrower than the width of the antenna pad.

Bricon antenna will record over the entire width of the pad and therefore tunnels are not needed. It is advisable however to slow down the bird before it steps onto the antenna. The base of the pad is the side bearing the label and pad number, and this should be installed face down.

It is advised to install the pads at least 1 metre away from each other to avoid interference.

NB: New generation pads (4 & 6 field - 2009 model onwards) can be placed next to one another.

#### **Antenna positioned under the landing board and before the bob wires**

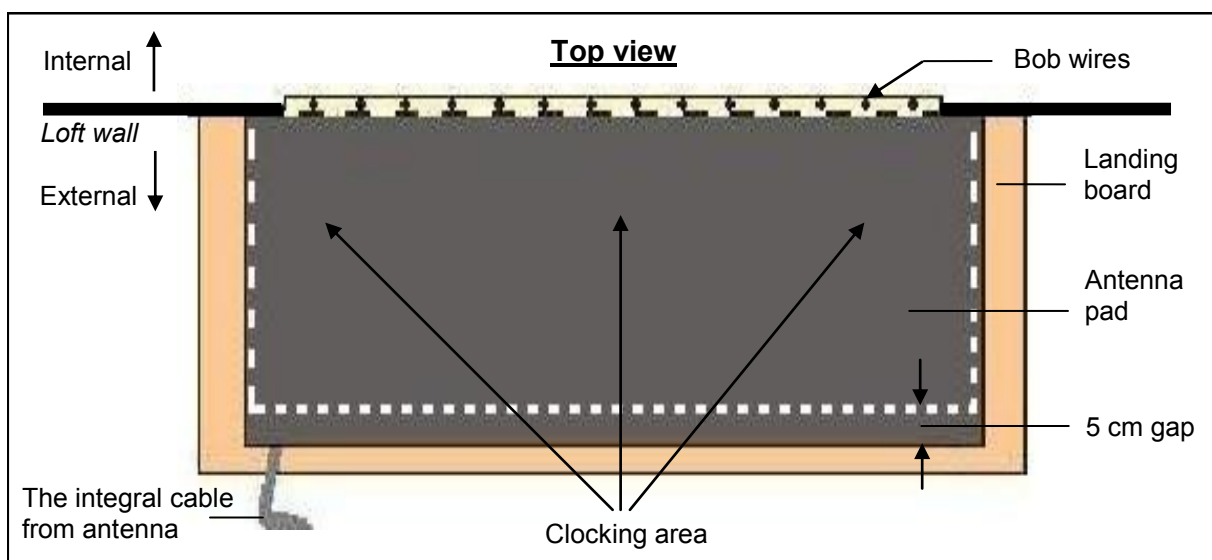
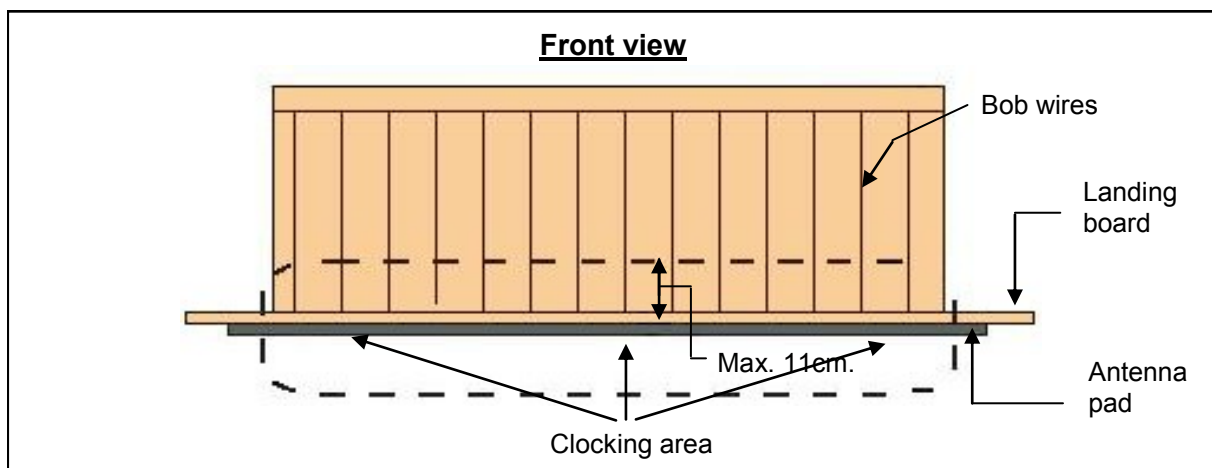

In this set-up, install the antenna pad with the integral cable leading to the outside of the loft.



## Antenna pad positioned inside of the loft entrance and behind the bob wire

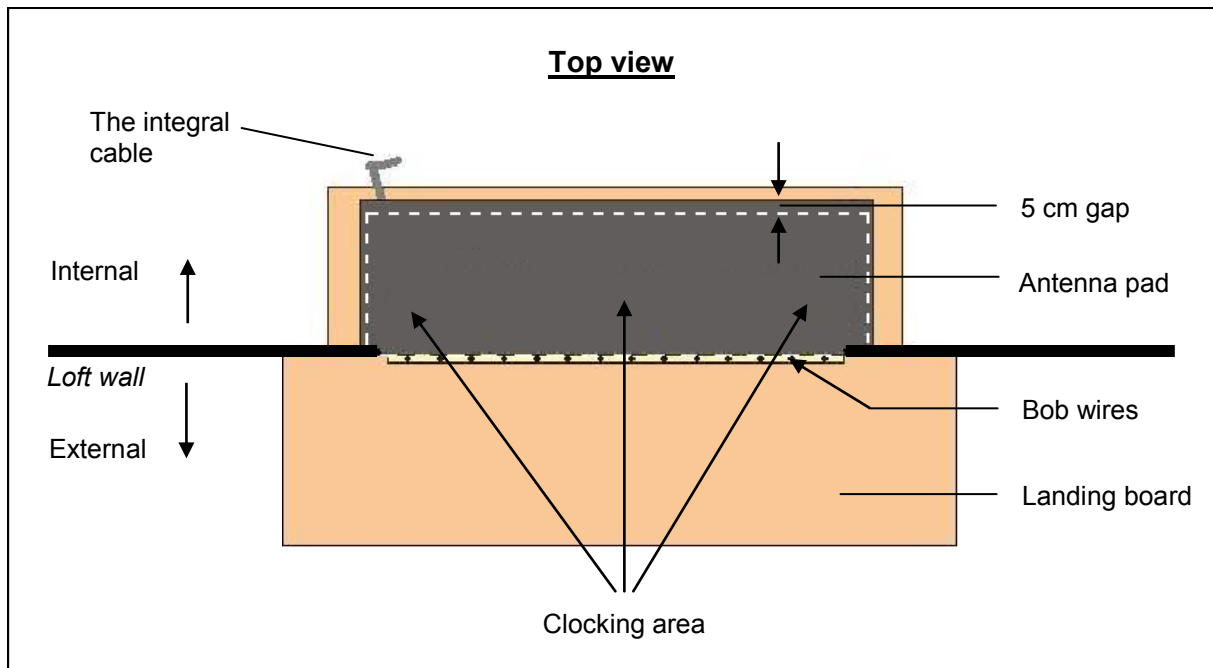

*In this set-up, install the antenna pad with the integral cable leading to the inside of the loft.*

### With tunnels

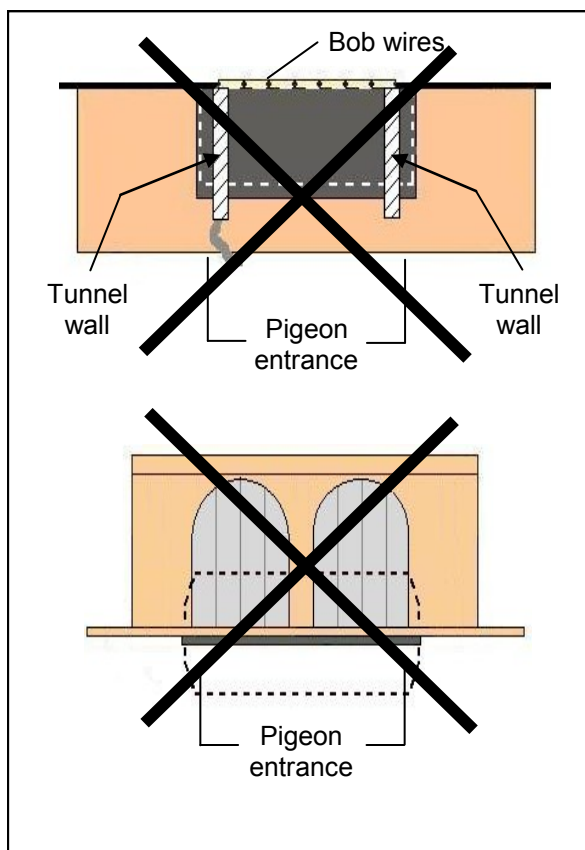

### Without tunnels

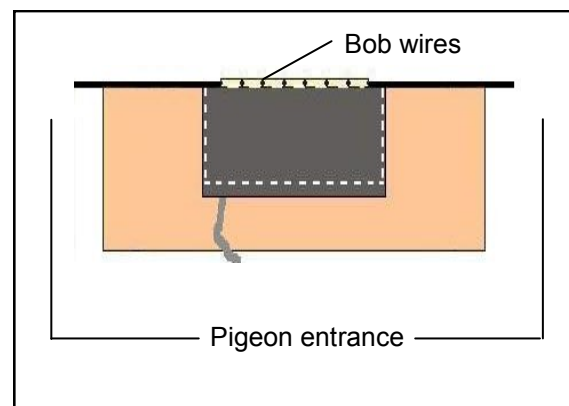

With Bricon antenna pads it is not necessary to place a tunnel over the pad because of the unique way in which the electro-magnetic fields actually overlap each other.

Having to place a tunnel over the pad and entrance will in most circumstances prove to be a major disadvantage, with pigeons crowding into the entrance area resulting in jams and delays in the timing of the birds.

## Clocking multiple pigeons on one antenna

If it is necessary to clock many pigeons on one antenna pad at the same time, it is advisable to install the antenna pad as follows.

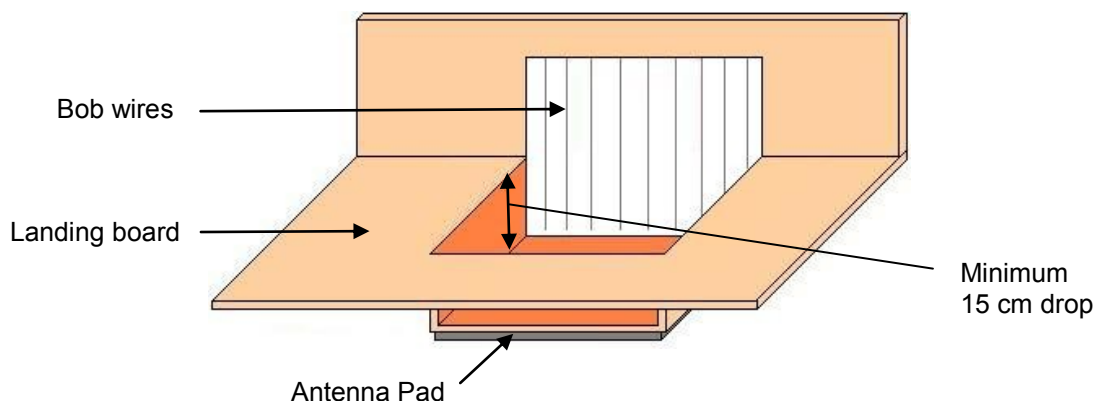

On the landing board, you should build an area which is lower, under which the antenna pad is then installed. The pigeons will then step onto the antenna pad one by one and not all at the same time and as a result the registration of the birds is optimised.

Another method that gives similar results is to build a raised area. This raised area is also needed if you have a landing board made from zinc, as metal causes interference to the antenna. The raised area should be a maximum 10cm higher than the base, and the board a maximum thickness of 15mm.

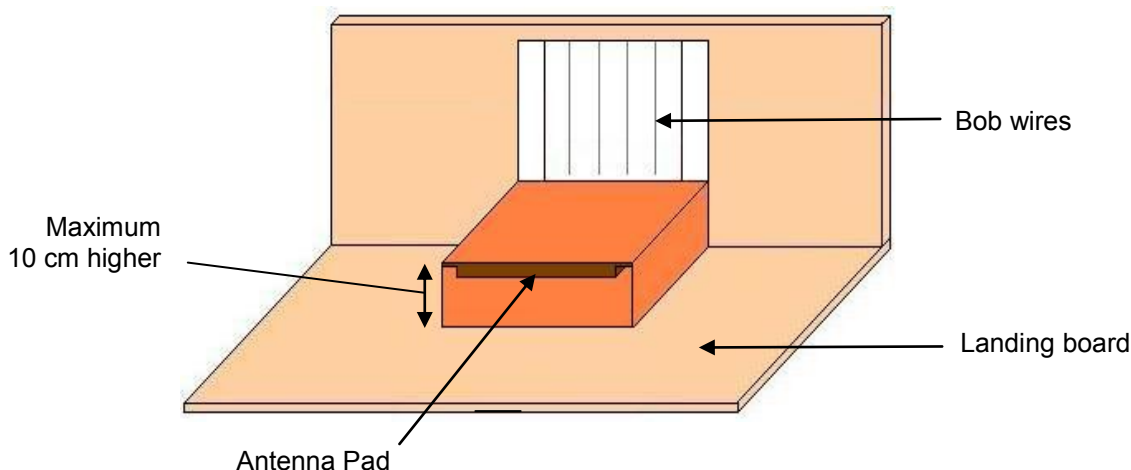

You may find it more convenient to purchase a specially designed entrance. If you choose this solution we recommend the Futura (designed by Bricon and produced by the companies Demster and Haspeslagh in Belgium).

**ATTENTION: It is recommended that great care is taken to ensure that the positioning of the antenna pad complies fully with the rules and regulations of the relevant governing body, as these placements are only suggestions.**

#### 4. Getting up and running with the system.

After programming additional antennas pads (see section 3.3) and installing the antenna system within the loft (see section 1.3), the power supply can then be connected to the completed loft system. The Speedy can be connected either prior to or after the connection of the power supply. The red light on the Antenna T-Connection box will illuminate, indicating that power is received.



- *Firmly push the Speedy into its wall holder.*
  - *The clock will start up and carry out a search for antennas.*
  - *If the antenna search is successful and a connection is found the Speedy clock will start in 'Clocking mode' and is ready to record birds (if linked).*
  - *To return to the menu press <C>.*
- ***Important:*** *If after the antenna search, the Speedy displays the icon menu then it indicates that the antenna search failed to find a connection with the antennas.*
  - *In that instance, check that all connections are firmly pushed fully together.*
  - *Ensure that the Speedy is fully pushed into the wall holder to ensure a good connection. Avoid having any debris sitting within the wall holder or over-tightening the connection cable into the base of the holder.*

#### 4.1. Input Fancier.

Your racing name and loft number can be entered into the clock by either of two ways.

- COMPUTER ENTRY using the software program 'Bricon Club-Editor'.  
*(this enables the address to also be entered).*
- DIRECT ENTRY into the Speedy clock as explained in the box below.



- *Navigate to 'Input/Edit Fancier' and press <OK> to confirm.*
- *With the buttons <PREVIOUS> and <NEXT> you can scroll through the fancier list. Press <OK> to confirm if you want to modify or change the name of the fancier.*
- *An empty field of 20 characters appears. Using <PREVIOUS> and <NEXT> a letter can be found. Continue pressing until you find the correct letter and confirm with <OK>. The cursor then moves to the right and you can repeat the action for the next letter. (NB: The space character can be found after the letter Z).*
- *On the second line you can add your official loft number, which should be entered in the format of two letters and five numbers.*
- *On completion, the Speedy will request final confirmation by pressing <OK> or to cancel the action with <C>.*

*To confirm that the name is entered, hold down the <C> and the name will show on the display.*

## 4.2. Linking Birds.

The next task is to add pigeons to the clock. An electronic chip ring must be assigned to each pigeon that you wish to time using the system, and with the Speedy you can have up to 200 birds linked.

There are two possible ways to enter birds into the Speedy.

- COMPUTER LINKING using the software program 'Bricon Club-Editor'.  
*Please note: members of the NEHU should use this option.*
- DIRECT LINKING to the clock with a loft antenna pad as the chip reader.  
The procedure for this is explained in the box below.

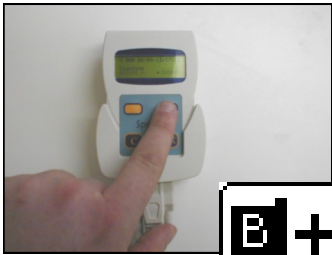

### Please note

The blank space can be found directly before the letter A and directly after the number 9.

When on the blank space <PREVIOUS> takes you to the numbers and <NEXT> to the letters.

- Navigate in the menu to the 'Linking' icon and press <OK>.
- Place the electronic ring on the antenna. Upon reading the chip the clock will beep and a formatted life ring number will appear.
- A ^ curser will be seen under the first character, indicating the letter or number that is next to be amended.
- Select the required letter or number by pressing the orange navigation buttons <PREVIOUS> or <NEXT> until the required letter or number appears under the ^ curser.
- Confirm with <OK> and the curser moves to the next character.
- Continue this process for the complete ring number of the pigeon.
- Sex is entered in the final position on the line (when the ^ curser is under the letter n of ant). Press <NEXT> to select 'H' for hen or leave the character space blank for a cock. Confirm with <OK>.
- A second display screen will then appear, where four characters are available in which to enter the colour of the pigeon.
- On completion, the Speedy will request that the linkage is confirmed by pressing <OK> or cancelled with <C>.
- By repeating this procedure the next pigeon can be entered.
- NB: Linking birds is blocked when races are active on the clock.

Four characters are available for the country or union, followed by two for the year of the bird. Nine characters are available for the letter and numbers of the pigeon and it is recommended that the ring number is entered into the final character spaces, with blank spaces used at the start.

The advised format for GB rings is ... GB(space)(space)-16-(space)(space)A(space)12345

**Chip already in use!** - indicates that the electronic chip ring is already linked to another pigeon.  
**Must delete old link** - indicates that an attempt has been made to link a chip to a pigeon ring that is already in the system. The link is denied and the old link must be deleted before proceeding.

## 4.3. Browse Pigeons.

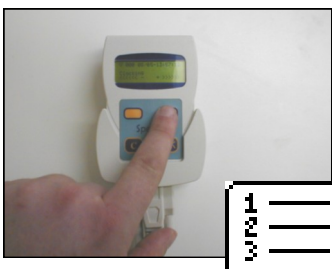

- This icon allows you to view or delete the birds on the clock.
- View the linked birds with the <PREVIOUS> and <NEXT>.
- If the clock is clear of races, then it is possible to delete pigeons.
- Scroll to a bird with <PREV> and <NEXT> then press <OK> and the clock will request confirmation for the pigeon to be deleted.
- Press <OK> to confirm the deletion or <C> to keep the bird.

#### 4.4. Clocking Birds from Training.



- When powered the Speedy carries out a search to determine the mode in which it should start-up.
- If connected loft antennas are not found during the search, the display of the Speedy will show the menu after the start-up.
- If connected antenna pads are found the Speedy will show either 'Clocking with: xx Ant' or the last recorded pigeon if previous clockings remain on the clock.
- NB: For security, if a race is active on the Speedy clock then it is impossible to leave clocking-mode.



- When there are no active races on the Speedy, pressing <C> deactivates 'clocking mode' and the main menu appears.
- The orange buttons <PREVIOUS> and <NEXT> can then be used to scroll through the menu. Position the required icon in the centre of the display and confirm with <OK>.
- To record birds from a training flight, it is necessary to delete the clockings of the previous training flight.

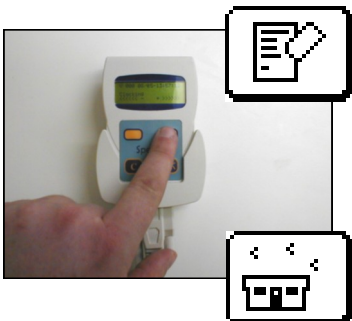

- **To delete training flights:** Select the 'Delete' icon and confirm with <OK> and all training clockings will be erased.  
NB: The clockings of active races will not be deleted.
- **Clocking:** Select the 'Clocking' icon and confirm with <OK> and the Speedy will return to clocking mode ready to record training flights.



- After pigeons have been recorded home, the orange navigation buttons <PREVIOUS> and <NEXT> allow you to scroll through the full list of clockings, moving backwards and forwards from the first to last pigeon.
- When a pigeon arrives the display will automatically show the latest clocking.



By pressing the <OK> button the screen display will alternate between a large sized print display and a smaller sized but more detailed print display.

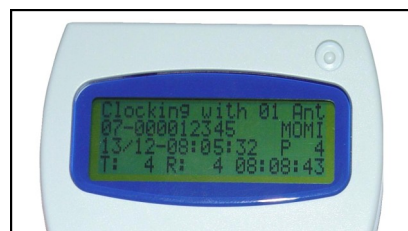



## 5. Racing with the Speedy.

### 5.1. Competing in a club that uses a Bricon Club-Master.



Refer to the **BRICON CLUB-MASTER** user guide for the instructions for basketing and read-out.

### 5.2. Competing in a club that uses an alternative brand of club master.

*(eg. Benzing, Tauris, Unikon etc).*

The Speedy clock is fully compliant with the Unives 1.7 Protocol so can be used to race basket on any brand of club master system that also complies with the agreed Unives protocol.

The Bricon Unives Cable (available as cost option) will be required to physically connect the Speedy to an alternative brand of master. The Unives cable has a nine-pin male connector on one end to plug into the base of the Speedy, whilst on the other end is a round four-pin male connector to connect to the alternative brand of club master.

### 5.3. Basketing on an alternative brand of club master.



- *The Speedy can be used with any brand of club master unit that complies with the Unives 1.7 protocol.*
- *A club master unit is a club basketing antenna and a time signal synchronised master clock.*
- *NB: The club master must have received its time synchronisation from a genuine automated time signal if the Speedy is to be able to time synchronise and race mark.*

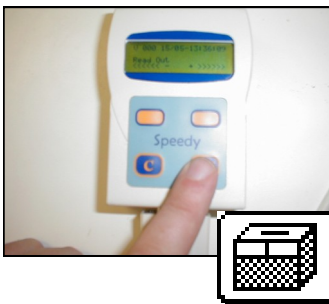

- **Basketing:** *A Bricon Unives cable is needed to connect the Speedy to the unives connector of the non-Bricon master unit.*
- *After start-up, the Speedy clock will recognise that it is connected to a club master and will show the 'Basketing' icon.*
- *Press <OK> on the Speedy to confirm basketing.*





- The Speedy will show 'Choose race' followed by a racepoint name or race number (eg RA01).
- Scroll through to the required racepoint (or number) with the <NEXT> button and then confirm with <OK>.
- A flight number will then appear after the racepoint name.
- If more than one race is being flown from that racepoint select a higher flight number with <NEXT>.
- Press <OK> on the Speedy to confirm your racepoint choice.



- Speedy will synchronise against the time held on the club unit.
- 'Basket Pigeon' will show and race basketing can commence.
- NB: If 'No synchronisation' appears on the Speedy this indicates that the club unit has not received a proper synchronisation from a valid time signal. NB: manually setting the time on the club unit is not a valid synchronisation.

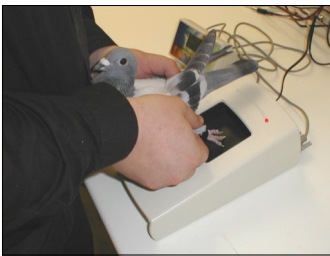

- Present the pigeon's electronic chip ring to the club antenna unit.
- The clock will beep and the ring number will show on the Speedy.
- Check that the ring number displayed corresponds to that on the pigeon before pressing <OK> to confirm its entry into the race.
- The pigeon can then be placed into the basket for the race.
- Repeat this process for each pigeon.



- 'Pigeon not found' indicates that an electronic chip is not linked.
- The option to 'Emergency Basket' will be given where the pigeon will have its linkage re-assigned to that fresh electronic chip.
- If an 'Emergency Basket' for the pigeon is required press <OK>.
- Use <PREVIOUS> and <NEXT> to scroll through the birds linked on the clock until the ring number of the pigeon appears.
- Press <OK> to confirm the emergency link of the pigeon to its new electronic chip ring, and then <OK> again to basket the bird.



- To close basketing, press <C> on the Speedy.
- Two copies of the basketing list will be printed.
- If additional copies of the basketing list are required, repeat the basketing process for the race to re-activate the print command.
- The Speedy can be disconnected from the club unit.



- At the loft, push the Speedy firmly into its wall holder.
- Always then check that the Speedy clock is ready to record birds by confirming that 'Clocking with: xx ant' shows on its display (where xx = number of connected antenna pads).
- If the Speedy shows the picture icon menu then the system is not connected correctly and will not record birds.

#### 5.4. Read out on an alternative brand of club master.

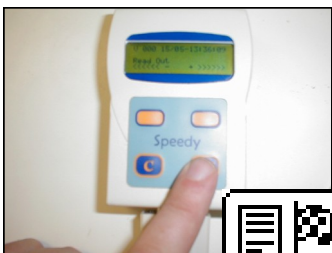

- When race clocking is completed, disconnect the Speedy clock from its wall holder.
- Return to the club headquarters and using the Bricon Unives cable connect the Speedy clock to the club master unit.
- Use <NEXT> to navigate to the 'Read out' icon on the Speedy menu and press the <OK>.

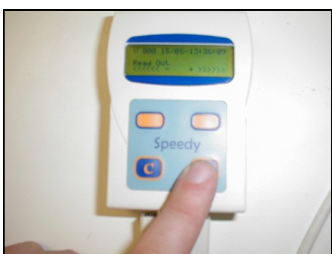

- 'Read out' will show along with a racepoint and flight number.
- Navigate to the required race with <NEXT> and then press <OK>.
- The time synchronisation with the club unit will be carried out automatically and two copies of the Clocking List will be printed
- Make sure that the required copies of the Clocking List have been printed and contain the required information.
- Close the race by pressing <OK> or keep the race open with <C>.
- NB : If additional copies are required - repeat the process.



- Implications of race closure.
- If the race was closed with the <OK> then it will have become a status 7 race, meaning that the race is now ready and waiting for deletion. (see section 6.2. for status codes).
- If the <C> was pressed, the race was not closed and remains fully active as a status 3 race and is not ready for deletion.

#### 5.5. To Delete a Race from the Speedy.

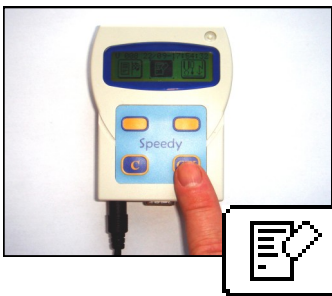

- After a race has been closed, the race must then also be deleted from the Speedy clock using the following routine.
- Connect the Bricon power supply jack directly into the base of the Speedy clock with no antenna pads connected.
- Using the <NEXT> button proceed to the 'Delete' icon.
- Press <OK> to delete all races that have been closed (status 7).
- Races anything other than status 7 will remain on the clock.
- NB : If a race is not closed and deleted then the birds within that race will not be allowed to be basketed for any future race.

## 6. Additional Functions and Features.

### 6.1. Setting the Date and Time.



- The 'Set time' icon enables the date and time to be set.
- Use the <NEXT> and <PREVIOUS> buttons to change a number and the <OK> to confirm the selected number.
- NB: When basketing for a race, the Speedy will time synchronise automatically to the club master mother clock, and this function is de-activated when a race is on the clock.

### 6.2. Basketed Races.

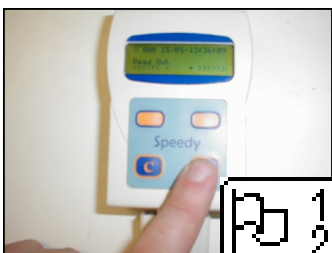

- Navigate to the 'Basketed races' icon and press <OK> to view the races that remain active on the Speedy.
- Press <NEXT> to scroll through each of the races on the clock.
- The second line of each active race shows the club ID and race point followed by the date and time when race marked.
- For example: 1234EXET 2106 193019 indicates the race is club ID 1234 from Exeter marked on 21st June at 19:30:19

#### Each active race is given a status code

- ⇒ Status 1. Race opened.
- ⇒ Status 3. Race read out but not closed.
- ⇒ Status 7. Read out printed and race closed ready for deletion.

Attention: An active race can only be deleted from the Speedy if it is status 7.

The only way to progress a race to become status 7 from any other status 1 or 3 is to return back to the master and repeat the read out print and when requested close the race by pressing <OK>.

If the Speedy has no races the icon will blink for a split second before the menu again shows.

### 6.3. Racepoints.

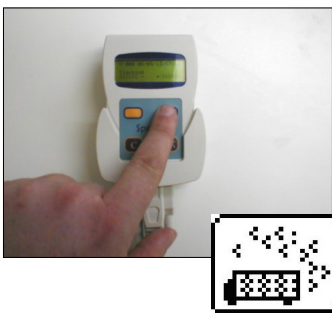

The Speedy can hold up to 25 racepoints (RA01 through to RA25) and names can be allocated to these numbers in one of two ways.

- (1). Computer entry by selecting from a racepoint list on the Bricon Club Editor and transferred to the Speedy via the Bricon Club-Master.
- (2). Direct entry on to the Speedy by navigating to the races icon and giving a 4 character name to any of numbers RA01 to RA25.

- To view the racepoints held on the clock, navigate to the racepoints icon press <OK> and scroll through with <NEXT>.
- Racepoints should be sent to the Speedy for races that are to be basketed on a non-Bricon brand of club master unit.
- NB: When basketing with a Bricon Club-Master, the racepoint is selected from the list of racepoints held on the Master.

## 6.4. Printing Lists

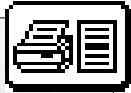

- The menu on the Speedy gives two printing options -
- (a) Clocking List - a report giving the full list of birds timed.
- (b) Overview List - a status report for every bird in the clock.
- To print a list the Speedy should be connected to a club system and any compatible printer.

## 6.5. The Antenna Alarm.

As part of its start up process the Speedy clock carries out a search for connected antenna pads and displays the number of different antenna pad identities that it has found in the search. The Speedy will continue to carry out regular antenna searches, and if at any time fewer pad identities are found than on the initial search (say due to a connection problem), then the antenna alarm will activate, giving a long continuous sound. Action can then be taken to find and rectify the issue. Please note that if the power to the clock is lost, then the antenna alarm will not be able to function.

## 6.6. Software Updates.

The Speedy receives free software updates via a connection to an updated Bricon Club-Master.

## 7. Optional System Enhancements.

### 7.1. Continuous Clocking with the Bricon Plus.

The Speedy is compatible for use with the 'Bricon Plus' the optional reserve clock that can take over and continue to record birds when the Speedy is removed from the loft system to go to the club house.

### 7.2. Bricon Print Manager.

The Bricon Print Manager software package (including a USB cable) is an optional extra which enables the information on the Speedy to be transferred and saved onto a home computer. The full details of every clocking for each race or training flight on the Speedy will be saved, along with the linkage data of each and every bird held on the Speedy. This information can then be viewed and printed at any time. The package comprises of a Print Manager CD and a special USB cable.

### 7.3 Clocking with two Speedy clocks.

Two Speedy clocks can be connected to the same loft antenna pad system by using a Split cable.

## 8. Unives 1.7 Compatibility.

The Speedy clock is fully compliant with the Unives 1.7 protocol, and can therefore be used with any brand of master system that also supports the agreed and established Unives 1.7 protocol. Bricon can supply a Bricon Unives Connection Cable, that has a 9 pin male connector to plug into the clock and a 4 pin male round connector to connect to the unives socket of the variant brand of master.

## 9. Maintenance and Service.

- The Speedy should only be used for the electronic timing of racing pigeons.
- Ensure that the Speedy is kept away from liquids, sunlight and extreme temperatures.
- Clean the Speedy by removing dirt with a lightly dampened cloth and do not use solvents.
- The battery within the Speedy clock will usually last for a minimum of 7 years from purchase.
- For customer confidence and reassurance, the clock has the self diagnostic Bricon Battery Control System (BBCS) that will give a warning message on screen should the clock develop a low battery.
- All repairs and service to the system should be referred to and ultimately carried out by Bricon.



## **10. Frequently Asked Questions.**

### **SYSTEM SET-UP**

- Q. How can I check that my name has been entered correctly into the Speedy ?  
A. When on the menu, if you hold down the C button, then both your name and the icon description will appear.
- Q. What is the cause if my Speedy lights up when connected, but only shows the icon menu ?  
A. The clock may not have been fully pushed in all the way, as the first part of the push only powers the clock. Check that there isn't something in the base of the wall holder stopping the clock from going fully in.
- Q. I wish to add additional Antenna pads, so how can I check that I will have sufficient power for them ?  
A. Each Antenna has a milliamp usage (mA) as indicated on its label and the clock uses another 70mA. Each Bricon transformer can give up to 1500mA of power. You should therefore calculate the power requirements of your complete system and add an extra additional power transformer where necessary.
- Q. I have obtained a second antenna pad. What must I do in order for it to operate as part of my system ?  
A. You must use antenna programming to re-number that pads own internal ID number held within its memory. Each antenna pad must have a different number to that of any other pad in the system.
- Q. What must I consider in order to have an additional antenna pad in a loft away from my existing loft ?  
A. It may be advised to give this separate antenna pad its own separate power supply, as when you send power through a long cable (20+ metres) then the voltage levels may fall below the levels required for that pad.
- Q. I already have 4 antenna pads and wish to add more pads in my Speedy system. What do I need ?  
A. When 5 or more pads are required, a Bricon antenna buffer must be fitted. Power must also be considered.
- Q. When linking birds directly onto the Speedy with the loft antenna, what ring format should I use ?  
A. The number should be entered in the format of 4 characters for the country or union id, followed by the year (eg. -16-) and then a further 9 characters for the letters and numbers (see section 3.1).
- Q. What is the cause if my Speedy is showing the words 'Start Main' on its display rather than the menu ?  
A. The clock has lost its software for whatever reason. Re-load the software from the Bricon Club-Master.

### **RACE PREPARATION & BASKETING**

- Q. I need to be at two club headquarters at the same time. Can I use two Speedy clocks to achieve this ?  
A. Yes, two clocks can be used on the same antenna pad system using a Bricon split cable. Each clock should hold the same pigeon data and each clock must be returned to the club where it was used for basketing.
- Q. How can I race with my Speedy clock, when basketing is to take place on an alternative brand of master ?  
A. You will need your Bricon Unives cable and also have the racepoint pre-entered into the Speedy clock.
- Q. Why is my Speedy clock showing a time variation against the master time on my basketing list ?  
A. An old race remains active on the clock for which the internal time is being maintained. Delete all of the races from the clock and it will then be able to time synchronise itself with the master time signal once again.
- Q. How can I check that my club has deleted all of the previous races from my Speedy clock ?  
A. Insert the power cable into the base of the clock, and go to the Basketed races icon (the 2nd icon ~ flag 1-2). Press the OK button and the details of any active races still sitting on the clock will be displayed on screen.

### **AT THE LOFT DURING A RACE**

- Q. What must I look for on the display of my Speedy clock, after I have connected it for a race ?  
A. On connection the clock will search for antennas and should state 'Clocking with xx Ant', where xx is the number of pad IDs found. It is important that this matches the number of pads in your system.
- Q. My clock has been connected in readiness for the return of race birds. How can I test my system ?  
A. Hold two un-linked chip rings over the pads, alternately lifting one ring away from the pad then the other.
- Q. Waiting for race birds to return, I have noticed that there are already birds showing as recorded on the clock.  
A. The clock will time any bird that has access to the pad, and thus birds not raced will record as trainers.
- Q. How can I view the details of the birds that have been recorded on my Speedy clock ?  
A. The last bird recorded will show on the display, and press the orange navigation buttons to scroll through the earlier birds recorded. Pressing the OK button gives you two display options, large character view giving the birds year and last four numbers, its position and clocking time, whilst the more detailed screen view gives additional information including the birds full ring number, the racepoint, date and time.

**For your own question answered - please contact Mark Palmer on 0121 357 7172 or [bricon.ets@live.com](mailto:bricon.ets@live.com)**

# Declaration of Conformity

Directive 1999/5/EC (R&TTE)

**BRICON nv**  
Europark Oost 15C,  
9100 Sint-Niklaas  
Belgium

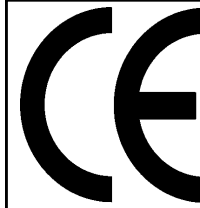

Loft antenna 1V-XXxxx  
Loft antenna 2V-XXxxx  
Loft antenna 4V-XXxxx  
Loft antenna 6V-XXxxx

*We declare on our own responsibility, that the products mentioned below to which this declaration relates, conform with the essential requirements and with other relevant provisions of the R&TTE directive (1999/5/EC).*

Article: Loft Antenna  
BRICON 1V(163mm), 2V(282mm), 4V(482mm), 6V(683mm).

Type: Reader for transponders (125kHz).

In accordance with Â§3 of R&TTE- the directive.

Health and Safety Â§3 (1) a:

Applied standard:

EN 60950:1992+A1+A2:1993+A3:1997+A11:1997

EMC §3(1)b:

Applied standard:

EN 301 489-3/07.200

Radio frequency spectrum Â§3 (2):

Applied standard:

EN 300 330-2 V1.1/7.2000

The technical file is available at the offices of the manufacturer.  
BRICON nv, Europark Oost 15C, Sint-Niklaas, Belgium.

Place and date of issue: Sint-Niklaas, Belgium. 13-12-2005.

Responsible for the manufacturer: Ivan Baetens  
CEO - Bricon nv

## 12. Technical specifications.

<i>Maximum number of pigeons : 200</i>
<i>Maximum number of races : 8</i>
<i>Number of fanciers : 1 or 3</i>
<i>Maximum number of antennas : 4</i>
<i>Maximum number of fields : 4 x 6 fields</i>
<i>With buffers added - max number of antennas : 64</i>
<i>Maximum cable length : 150 metres</i>